

Project Name:	Type:
Product Code:	Date:

VANILLA SMALL 2 ADJUSTABLE DOWNLIGHT



Vanilla Small 2 Adjustable Downlight

The Vanilla product family is a small recessed adjustable downlight providing high visual comfort thanks to a deep recessed LED Engine. Vanilla comes with a modular and tool free LED-engine and optical accessories that are field changeable. Fixture is serviceable through the aperture.

The Body is made of high grade Aluminum. The fixture is tilttable vertically 0-32° and rotatable horizontally 355°. Adjustable 32° always inside ceiling level. The fixtures is provided standard with retrofit housing.



PERFORMANCE

	STATIC WHITE LED	WARM DIM LED
CCT:	2700K / 3000K	1800K - 3000K
CRI:	97 CRI / 10° 90 CRI	90 CRI
WATTAGE:	9 W(250 mA) / 10° 10 W(700mA)	6 WATTS (350 mA)
LUMENS:	766 Delivered / 10° 1200 Delivered	553 Delivered
SDMC:	2 Step / 10° 2 Step	2 Step

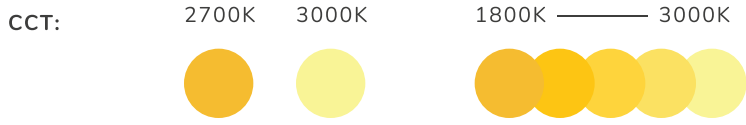

DRIVER SPECIFICATIONS

	STATIC WHITE		WARM DIM
DRIVER:	E3	E7	EW
DIMMING PROTOCOL:	ELV 2 Wire	ELV 2 Wire	ELV 2 Wire
LED CLASS:	2 Output	2 Output	2 Output
AC INPUT	110-277VAC 120-50 mA 47-63 HZ	120 V AC 0-11 mA 47-63 HZ	120 V AC 0.11 A 47-63 Hz
DC OUTPUT:	250mA	700mA	350mA

KEY DIMENSIONS

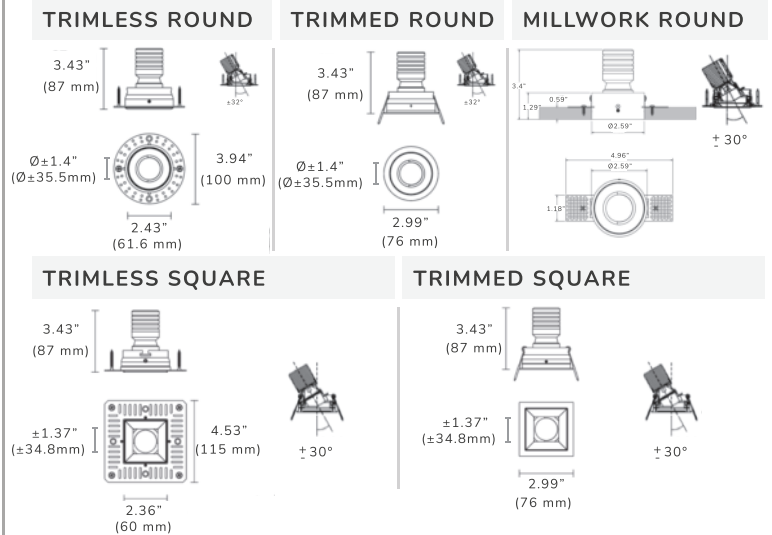

HOUSING SPECIFICATIONS

RETROFIT DRIVE ENCLOSURE SPECS | C-05

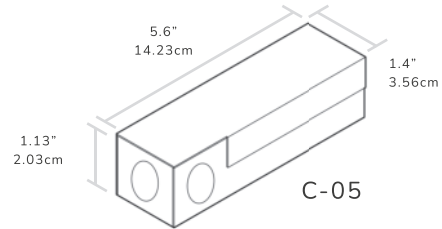

ELV Standard 2-Wire Dimming

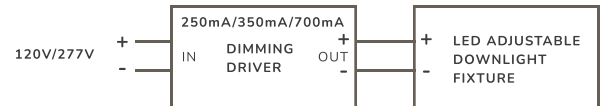

*FOR OTHER DIMMING STYLES CONTACT LGN

** 250MA DRIVER FOR STATIC WHITE / 350MA DRIVER FOR WARM DIM

TRIM OPTIONS

R3 - ROUND

TRIM TYPE	TL TRIMLESS	TR TRIMMED	FINISH
FX FLAT IP20 (DRY)			 W WHITE
CX CONCAVE IP20 (DRY)			 B BLACK
FH FLAT HEXCELL IP20 (DRY)			 C CUSTOM
FS FLAT SOLITE SHOWER IP44 (WET)			
CS CONCAVE SOLITE SHOWER IP44 (WET)			

S3 - SQUARE

FX FLAT IP20 (DRY)			
CX CONCAVE IP20 (DRY)			
FH FLAT HEXCELL IP20 (DRY)			
FS FLAT SOLITE SHOWER IP44 (WET)			

ORDER INFORMATION

Order Code

VAN	PROFILE	TRIM TYPE	FINISH	TEMP	OPTICS	DRIVER	HOUSING	ACCESSORIES
VAN	RTR3 ROUND TRIMMED	FX FLAT -IP20	W WHITE	273 2700K	10	E7 ELV**	RT RETROFIT	X2 2 FIXTURE TRIMLESS MUD KIT X4 4 FIXTURE TRIMLESS MUD KIT
	RTL3 ROUND TRIMLESS	CX CONCAVE - IP20	B BLACK	303 3000K	18	E3 ELV		
	STR3 SQUARE TRIMMED	FH FLAT HEXCELL -IP20	C CUSTOM *		24	XX OTHER***		
	STL3 SQUARE TRIMLESS	FS FLAT SOLITE SHOWER - IP44			34			
	RML3 ROUND MILLWORK	CS CONCAVE SOLITE SHOWER -IP44		WD3 (1800 K - 3000K)	17	EW ELV		
					27			
					35			
					62			

*CUSTOM FINISHES REQUIRE A MINIMUM QUANTITY OF 25 FIXTURES

**E7 DRIVER FOR 10 DEGREE OPTIC ONLY

***OTHER DIMMING OPTIONS AVAILABLE UPON REQUEST

****CONCAVE SOLITE ONLY AVAILABLE ON ROUND TRIM TYPE

ACCESSORIES

X2 - 4" Center to Center Spacing

ROUND

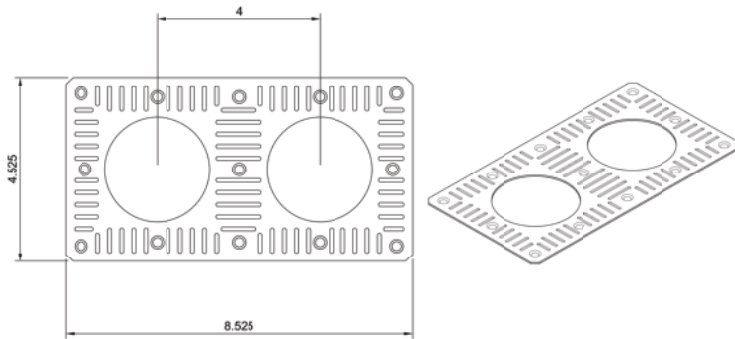

SQUARE

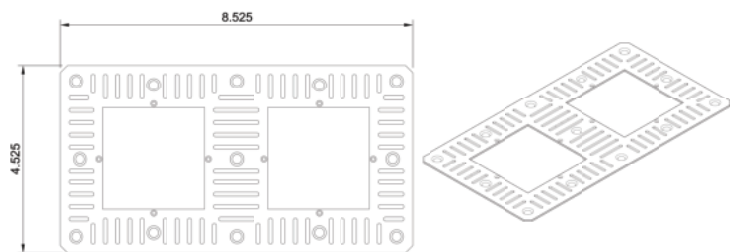

X4 - 4" Center to Center Spacing

ROUND

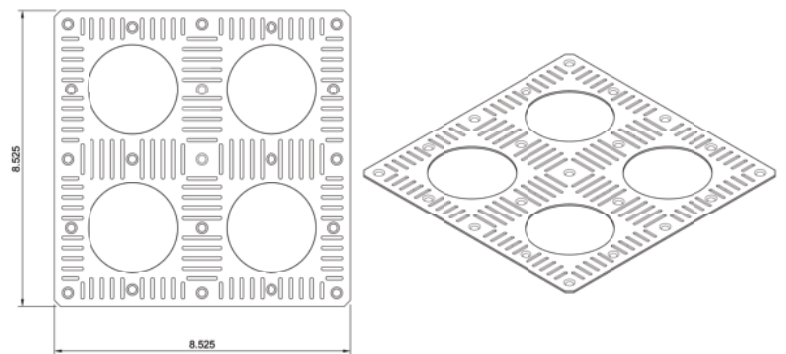

SQUARE

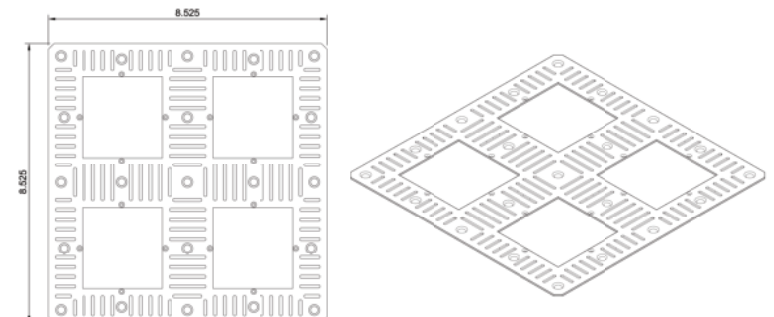

Fixture Components



Housing / Retrofit Enclosure Specifications

E3 (2 Inch) Product Data

Specifications:

Dimensions:	5.6" (14.23cm) x 1.4" (3.56cm) x 1.13" (2.03cm)
IP Rating:	IP 20
Light Source:	LED
AC Input:	110-277 VAC - 120-50mA 47-63 Hz

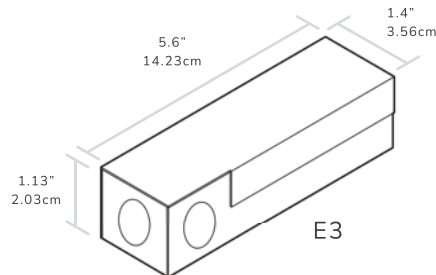

INSTALLATION GUIDE

Trimless

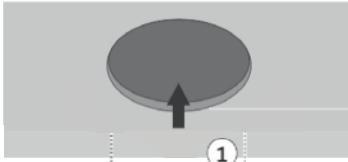

Ceiling Cutout:
2 3/4 inches / 70 mm

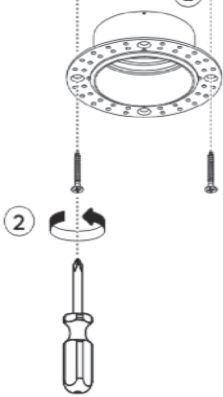

MUD PLATE
Required for installation in ceiling cutout

Screws
Plaster rig is installed at ceiling cutout using screws



Plaster
Before plastering and painting, cover the opening with cardboard.



Paint
Once finished painting and plastering remove the cardboard cover.

Trimmed

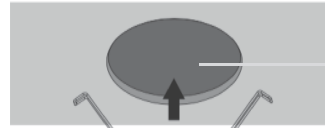

Ceiling Cutout:
2.76 inches/70 mm

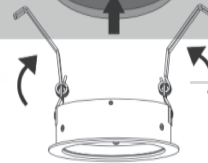

Butterfly Clips
Hold trimless fixtures in place

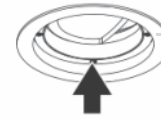

Gimbal Magnets
The gimbal snaps into place via magnets within the trim



Trim Magnets
The trim type also snaps into place using magnets for stress free installations

Millwork

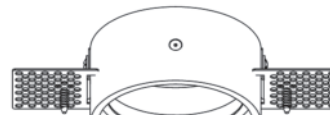

Millwork Mount:
Installed from the back, with two set screws, height adjustable



Millwork Cutout:
2.59 inches/66 mm
see dimensions above for fixture measurements



LED Module
Attached to the adjustable ring will snap into the Millwork mount



Adjustable Ring
Snaps into the Millwork mount



Trim Magnets
The trim type also snaps into place using magnets for stress free installations